

K 01 / ALFA / LENS DOOR: Tempered reflective black glass (4mm thickness) with an aluminum frame. The handle is Albi.

K 02 / ALFA / DOLE DOOR: Aluminum-framed smoked mirror cover with MDF support at the back for reinforcement. The handle is Albi.

K 03 / ALFA / LYON DOOR: Smoked mirror cover attached to a melamine board. The handle is Piza.

K 04 / ALFA / REZE DOOR: 18mm MDF cover with a specially processed painted aluminum frame. The handle is Albi.

K 05 / ALFA / LAVAL DOOR: 18mm melamine-coated board cover. The handle is Laval.

K 06 / ALFA / PIZA DOOR: 18mm melamine-coated board cover. The handle is Piza.

K 07 / ALFA / ALBI DOOR: 18mm melamine-coated board cover. The handle is Albi.

Hinged Door Alternatives



K 01

ALFA
LENS



K 02

ALFA
DOLE



K 03

ALFA
LYON



K 04

ALFA
REZE



K 05

ALFA
LAVAL



K 06

ALFA
PIZA



K 07

ALFA
ALBI

K 08 / ALFA / LENS SLIDING DOOR:

A sliding door with an aluminum frame and tempered, reflective black glass.

K 09 / ALFA / DOLE SLIDING DOOR: A sliding door with an aluminum frame and 4 mm smoked mirror. The back of the mirrors are reinforced with MDF.

K 10 / ALFA / LYON SLIDING DOOR:

A sliding door with an aluminum handle and an 18 mm melamine board. Half of the door is covered with 4 mm smoked mirror. It comes in 5 different colors.

K 11 / ALFA / ALBI SLIDING DOOR: A sliding door with an aluminum handle and an 18 mm melamine board. It comes in 5 different colors.

Sliding Door Alternatives



K 08

ALFA
LENS
SLIDING
DOOR



K 09

ALFA
DOLE
SLIDING
DOOR



K 10

ALFA
LYON
SLIDING
DOOR



K 11

ALFA
ALBI
SLIDING
DOOR

alfa plus main cabinets 210 cm

G 01 ALFA
(SINGLE MAIN CABINET)



KG: 40,0 m³: 0,09

G 02 ALFA
(DOUBLE MAIN CABINET)

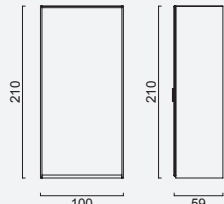

KG: 53,0 m³: 0,10

G 03 ALFA
(CABINET WITH SLIDING DOORS)

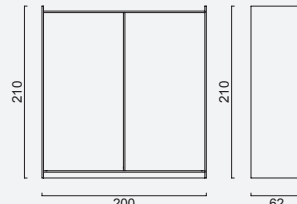

KG: 100,0 m³: 0,20

D 09 ALFA
(CORNER CABINET)

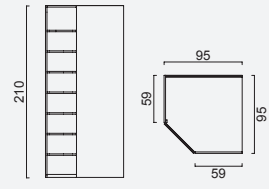

KG: 128,0 m³: 0,23

D 10 ALFA
(MIDDLE MODULE CABINET)
W: 20 - 25 - 30 - 35 - 40 - 45 cm)

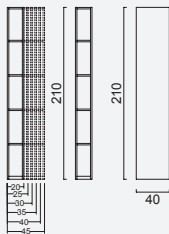

20 cm KG: 9,0 m³: 0,05
 25 cm KG: 10,0 m³: 0,05
 30 cm KG: 13,0 m³: 0,07
 35 cm KG: 18,0 m³: 0,07
 40 cm KG: 27,0 m³: 0,08
 45 cm KG: 35,0 m³: 0,08

alfa plus main cabinets 230 cm

G 01 ALFA
(SINGLE MAIN CABINET)

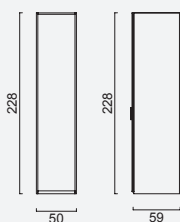

KG: 43,0 m³: 0,11

G 02 ALFA
(DOUBLE MAIN CABINET)

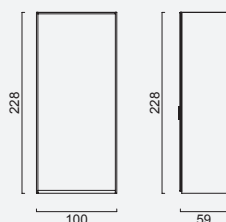

KG: 56,0 m³: 0,10

G 03 ALFA
(CABINET WITH SLIDING DOORS)

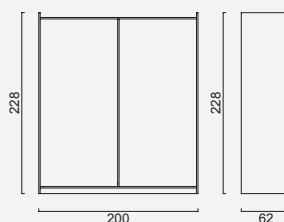

KG: 73,0 m³: 0,18

D 09 ALFA
(CORNER CABINET)

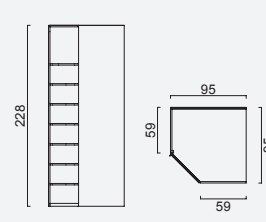

KG: 135,0 m³: 0,40

D 10 ALFA
(MIDDLE MODULE CABINET)
W: 20 - 25 - 30 - 35 - 40 - 45 cm

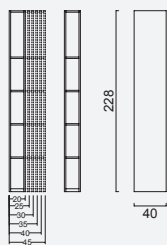

20 cm KG: 10,0 m³: 0,05
25 cm KG: 11,0 m³: 0,05
30 cm KG: 14,0 m³: 0,07
35 cm KG: 19,0 m³: 0,07
40 cm KG: 28,0 m³: 0,08
45 cm KG: 36,0 m³: 0,08

alfa plus main cabinets 245 cm

G 01 ALFA
(SINGLE MAIN CABINET)



G 02 ALFA
(DOUBLE MAIN CABINET)



G 03 ALFA
(CABINET WITH SLIDING DOORS)



D 09 ALFA
(CORNER CABINET)

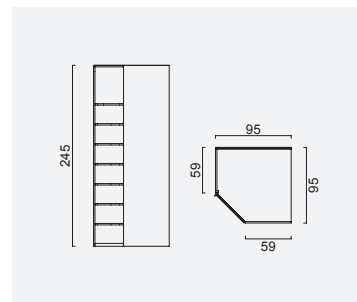
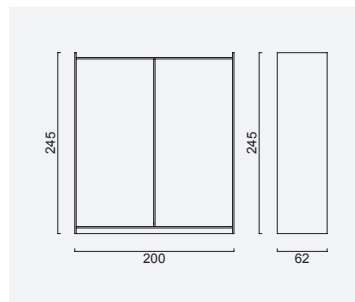
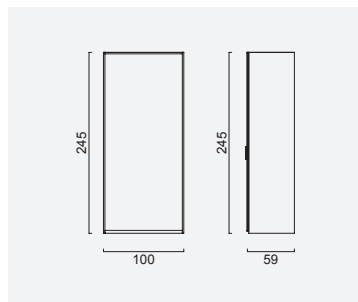
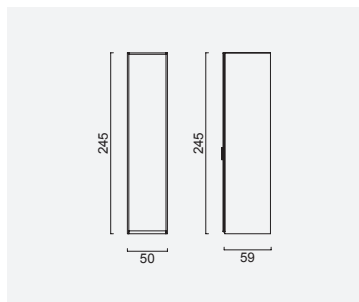

D 10 ALFA
(MIDDLE MODULE CABINET)
W: 20 - 25 - 30 - 35 - 40 - 45 cm)

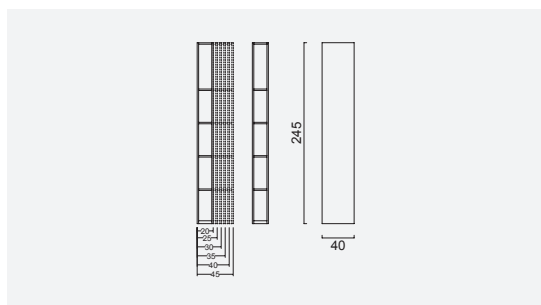

alfa plus main cabinets 260 cm

G 01 ALFA
(SINGLE MAIN CABINET)

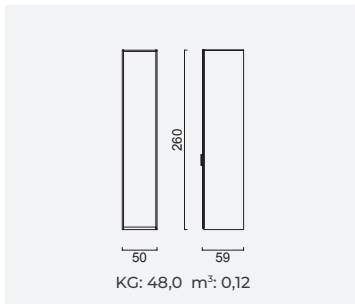

G 02 ALFA
(DOUBLE MAIN CABINET)

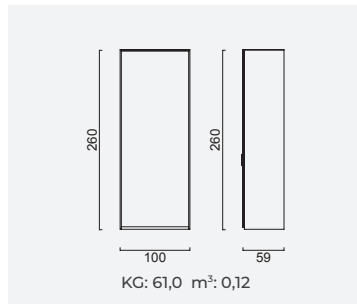

G 03 ALFA
(CABINET WITH SLIDING DOORS)

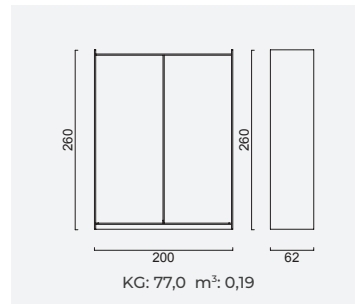

D 09 ALFA
(CORNER CABINET)

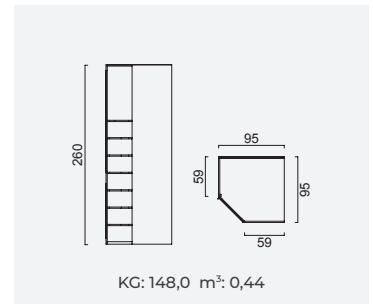

D 10 ALFA
(MIDDLE MODULE CABINET)
W: 20 - 25 - 30 - 35 - 40 - 45 cm

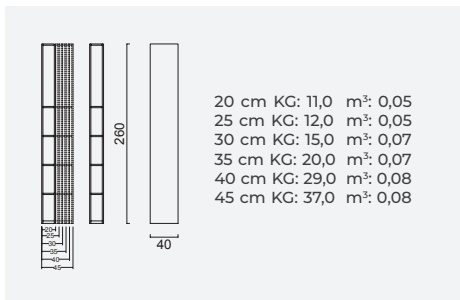

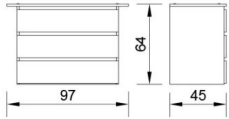

M 01

ALFA
DRAWERS
MODULE

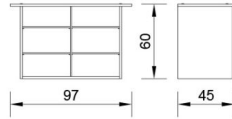

M 02

ALFA
T-SHIRT
ORGANIZER
MODULE

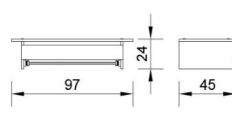

M 03

ALFA
JEWELLRY
ORGANIZER
AND TROUSER
RACK MODULE

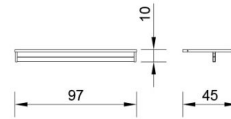

M 04

ALFA
LONG SHELF
MODULE WITH
HANGER

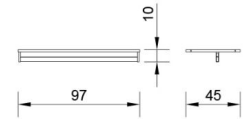

M 05

ALFA
LONG SHELF
MODULE WITH
HANGER 2
PCS.

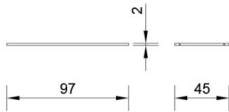

M 06

ALFA
LONG SHELF
MODULE

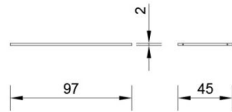

M 07

ALFA
LONG SHELF
MODULE 2
PCS.

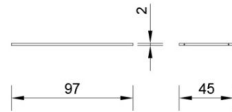

M 08

ALFA
LONG SHELF
MODULE 3
PCS.

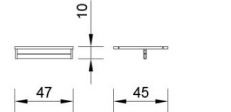

M 09

ALFA
SHORT SHELF
MODULE WITH
HANGER

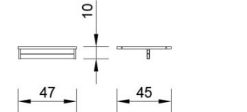

M 10

ALFA
SHORT SHELF
MODULE WITH
HANGER 2
PCS.

M01/ALFA/Drawers Module: Consists of three deep and wide drawers with telescopic rails. Drawer bottoms are 8mm thick.

M02/ALFA/T-shirt organizer Module: Ideal storage unit for shirts and sweaters, with six compartments made of 8mm rails.

M03/ALFA/Jewelry Organizer and Trousers Rack Module: An organizer with eight compartments for jewelry and a rail system for hanging up to seven pants. The material is coated with elastomer for slip resistance.

M04/M05/ALFA/Long shelf Module with Hanger: Features a non-slip, noiseless aluminum hanging tube coated with elastomer, with a length of 97 cm.

M06/M07/M08/ALFA/Long Shelf Module: Consists of shelves with a length of 97 cm, connected with 18mm-thick rafix connectors.

M09/M10/ALFA/Short Shelf module with Hanger: A 47 cm-long module with a non-slip, noiseless aluminum hanging tube coated with elastomer.

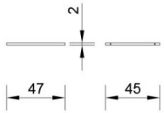

M 11

ALFA
SHORT SHELF
MODULE

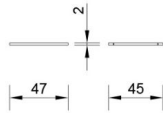

M 12

ALFA
SHORT SHELF
MODULE
2 PCS.

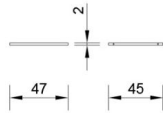

M 13

ALFA
SHORT SHELF
MODULE
3 PCS.

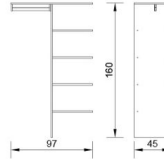

M 14

ALFA
SEPARATOR
MODULE WITH
SHELVES

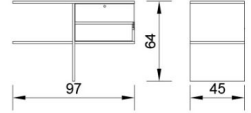

M 15

ALFA
HIDDEN
COMPARTMENT
MODULE

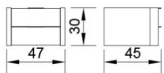

M 16

ALFA
SHORT
DRAWERS
MODULE

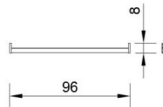

M 17

ALFA
LONG
HANGER

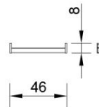
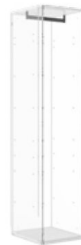

M 18

ALFA
SHORT
HANGER

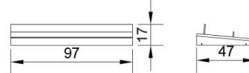

M 19

ALFA
SHOES
ORGANIZER
MODULE

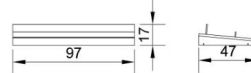

M 20

ALFA
SHOES
ORGANIZER
MODULE 2
PCS.

M11/M12/M13/ALFA/Short Shelf Module:
Features 18mm-thick rafix connectors, with shelves 47 cm in length.

M14/ALFA/Separator Module with Shelves: A module suitable for hanging long dresses, with five compartments for storing sweaters and shirts.

M15/ALFA/Hidden Compartment Module:
A unit with a fingerprint and password-protected lock system designed to store your personal belongings securely.

M16/ALFA/Short Drawers Module: A telescopic rail system module for fitting into narrow spaces between shelves.

M17/M18/ALFA/Long and Short Hangers:
A module consisting of non-slip, scratch-resistant, and noiseless elastomer-coated hanging tubes suitable for attaching to all upper panels in ALFA modules. Available in sizes 96cm and 46cm.

M19/M20/ALFA/Shoes Organizer Modules:
An open structure module for storing all types of shoes, with two rows. Suitable for installation in double-door cabinets.

210 CM
Our Suggestions

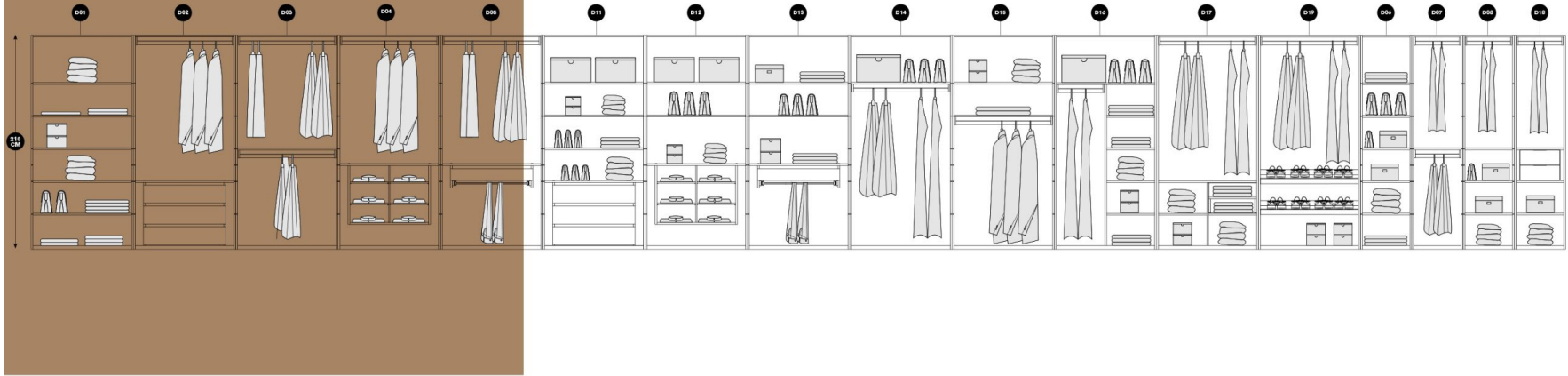

ALFA
210 CM
Wardrobe Modules

D 01-210
ALFA
DOUBLE
CABINET WITH
5 SHELVES

Content of this Order;
G 02-210 1 pc.
M 07 1 pc.
M 08 1 pc.

Consists of these modules.

D 02-210
ALFA
DOUBLE
CABINET WITH
DRAWERS
MODULE

Content of this Order;
G 02-210 1 pc.
M 01 1 pc.
M 17 1 pc.

Consists of these modules.

D 03-210
ALFA
DOUBLE
CABINET WITH
HANGER

Content of this Order;
G 02-210 1 pc.
M 04 1 pc.
M 17 1 pc.

Consists of these modules.

D 04-210
ALFA
DOUBLE
CABINET
WITH T-SHIRT
ORGANIZER

Content of this Order;
G 02-210 1 pc.
M 02 1 pc.
M 17 1 pc.

Consists of these modules.

D 05-210
ALFA
DOUBLE CABINET
WITH TROUSER
RACK

Content of this Order;
G 02-210 1 pc.
M 03 1 pc.
M 17 1 pc.

Consists of these modules.

D 11-210
ALFA
DOUBLE
CABINET WITH
4 SHELVES
AND DRAWERS
MODULE

Content of this Order;
G 02-210 1 pc.
M 01 1 pc.
M 08 1 pc.

Consists of these modules.

D 12-210
ALFA
DOUBLE
CABINET
WITH T-SHIRT
ORGANIZER

Content of this Order;
G 02-210 1 pc.
M 02 1 pc.
M 07 1 pc.

Consists of these modules.

D 13-210
ALFA
CABINET
WITH TROUSER
RACK

Content of this Order;
G 02-210 1 pc.
M 03 1 pc.
M 07 1 pc.

Consists of these modules.

D 14-210
ALFA
DOUBLE
CABINET WITH
SINGLE SHELF

Content of this Order;
G 02-210 1 pc.
M 04 1 pc.

Consists of these modules.

D 15-210
ALFA
DOUBLE
CABINET WITH
A SHELF

Content of this Order;
G 02-210 1 pc.
M 04 1 pc.
M 05 1 pc.

Consists of these modules.

D 16-210
ALFA
DOUBLE
CABINET WITH
SEPARATOR
MODULE AND
SHELVES

Content of this Order;
G 02-210 1 pc.
M 14 1 pc.

Consists of these modules.

D 17-210
ALFA
DOUBLE
CABINET WITH
HIDDEN
COMPARTMENT
MODULE

Content of this Order;
G 02-210 1 pc.
M 15 1 pc.
M 17 1 pc.

Consists of these modules.

D 19-210
ALFA
DOUBLE
CABINET
WITH SHOES
ORGANIZER

Content of this Order;
G 02-210 1 pc.
M 20 1 pc.
M 17 1 pc.

Consists of these modules.

D 06-210
ALFA
SINGLE
CABINET WITH
5 SHELVES

Content of this Order;
G 01-210 1 pc.
M 12 1 pc.
M 13 1 pc.

Consists of these modules.

D 07-210
ALFA
SINGLE
CABINET
WITH
HANGER

Content of this Order;
G 01-210 1 pc.
M 18 1 pc.
M 09 1 pc.

Consists of these modules.

D 08-210
ALFA
SINGLE
CABINET WITH
3 SHELVES AND
A HANGER

Content of this Order;
G 01-210 1 pc.
M 13 1 pc.
M 16 1 pc.

Consists of these modules.

D 18-210
ALFA
SINGLE
CABINET WITH
DRAWERS
MODULE

Content of this Order;
G 01-210 1 pc.
M 13 1 pc.
M 18 1 pc.
M 16 1 pc.

Consists of these modules.

228 CM
Our Suggestions

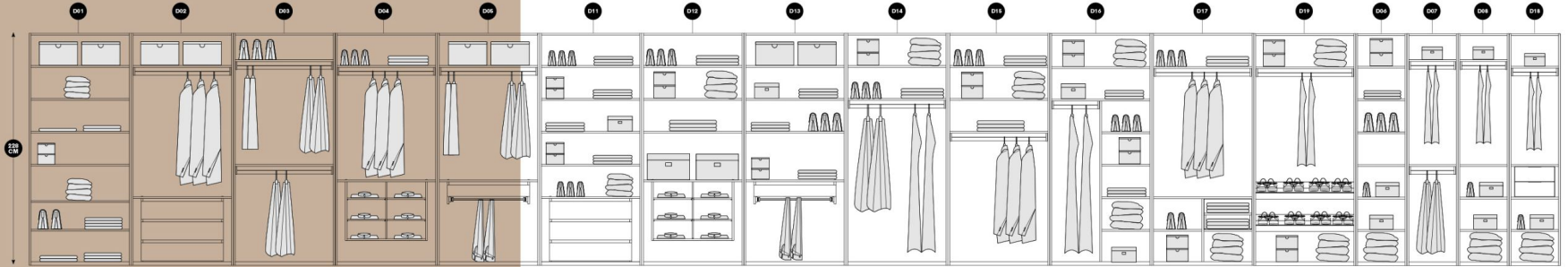

ALFA
228 CM
Wardrobe Modules

D 01-228
ALFA
DOUBLE
CABINET
WITH
5 SHELVES

Content of this Order;
G 02-228 1 pc.
M 08 2 pcs.
Consists of these modules.

D 02-228
ALFA
DOUBLE
CABINET WITH
DRAWERS
MODULE

Content of this Order;
G 02-228 1 pc.
M 01 1 pc.
M 04 1 pc.
Consists of these modules.

D 03-228
ALFA
DOUBLE
CABINET
WITH HANGER

Content of this Order;
G 02-228 1 pc.
M 05 1 pc.
Consists of these modules.

D 04-228
ALFA
DOUBLE
CABINET
WITH T-SHIRT
ORGANIZER

Content of this Order;
G 02-228 1 pc.
M 04 1 pc.
M 02 1 pc.
Consists of these modules.

D 05-228
ALFA
DOUBLE
CABINET
WITH
TROUSER
RACK

Content of this Order;
G 02-228 1 pc.
M 04 1 pc.
M 03 1 pc.
Consists of these modules.

D 11-228
ALFA
DOUBLE
CABINET WITH
4 SHELVES
AND DRAWERS
MODULE

Content of this Order;
G 02-228 1 pc.
M 01 1 pc.
M 07 2 pc.
Consists of these modules.

D 12-228
ALFA
DOUBLE
CABINET
WITH T-SHIRT
ORGANIZER

Content of this Order;
G 02-228 1 pc.
M 02 1 pc.
M 08 1 pc.
Consists of these modules.

D 13-228
ALFA
CABINET
WITH TROUSER
RACK

Content of this Order;
G 02-228 1 pc.
M 03 1 pc.
M 08 1 pc.
Consists of these modules.

D 14-228
ALFA
DOUBLE
CABINET
WITH
SINGLE
SHELF

Content of this Order;
G 02-228 1 pc.
M 04 1 pc.
M 06 1 pc.
Consists of these modules.

D 15-228
ALFA
DOUBLE
CABINET WITH
A SHELF

Content of this Order;
G 02-228 1 pc.
M 04 1 pc.
M 07 1 pc.
Consists of these modules.

D 16-228
ALFA
DOUBLE
CABINET WITH
SEPARATOR
MODULE AND
SHELVES

Content of this Order;
G 02-228 1 pc.
M 14 1 pc.
M 06 1 pc.
Consists of these modules.

D 17-228
ALFA
DOUBLE
CABINET WITH
HIDDEN
COMPARTMENT
MODULE

Content of this Order;
G 02-228 1 pc.
M 15 1 pc.
M 04 1 pc.
Consists of these modules.

D 19-228
ALFA
DOUBLE
CABINET
WITH SHOES
ORGANIZER

Content of this Order;
G 02-228 1 pc.
M 20 1 pc.
M 04 1 pc.
Consists of these modules.

D 06-228
ALFA
SINGLE
CABINET
WITH
5 SHELVES

Content of this Order;
G 01-228 1 pc.
M 13 2 pcs.
Consists of these modules.

D 07-228
ALFA
SINGLE
CABINET
WITH
HANGER

Content of this Order;
G 01-228 1 pc.
M 10 1 pc.
Consists of these modules.

D 08-228
ALFA
SINGLE
CABINET WITH
3 SHELVES
AND
A HANGER

Content of this Order;
G 01-228 1 pc.
M 09 1 pc.
M 13 1 pc.
Consists of these modules.

D 18-228
ALFA
SINGLE
CABINET
WITH
DRAWERS
MODULE

Content of this Order;
G 01-228 1 pc.
M 14 1 pc.
M 13 1 pc.
M 09 1 pc.
Consists of these modules.

245 CM
Our Suggestions

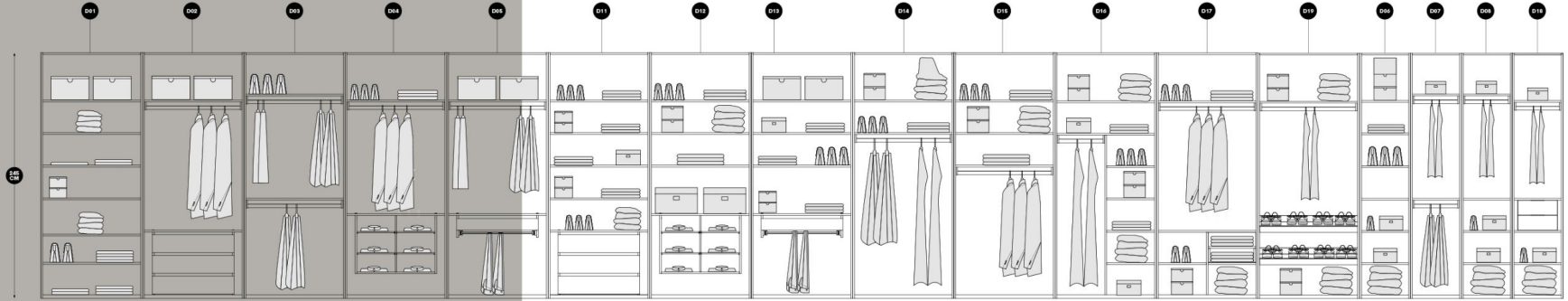

ALFA
245 CM
Wardrobe Modules

D 01-245
ALFA
DOUBLE
CABINET
WITH
5 SHELVES

Content of this Order;
G 02-245 1 pc.
M 08 2 pcs.

Consists of these modules.

D 02-245
ALFA
DOUBLE
CABINET WITH
DRAWERS
MODULE

Content of this Order;
G 02-245 1 pc.
M 01 1 pc.
M 04 1 pc.

Consists of these modules.

D 03-245
ALFA
DOUBLE
CABINET
WITH HANGER

Content of this Order;
G 02-245 1 pc.
M 05 1 pc.

Consists of these modules.

D 04-245
ALFA
DOUBLE
CABINET
WITH T-SHIRT
ORGANIZER

Content of this Order;
G 02-245 1 pc.
M 04 1 pc.
M 02 1 pc.

Consists of these modules.

D 05-245
ALFA
DOUBLE CABINET
WITH TROUSER
RACK

Content of this Order;
G 02-245 1 pc.
M 04 1 pc.
M 03 1 pc.

Consists of these modules.

D 11-245
ALFA
DOUBLE
CABINET WITH
4 SHELVES
AND DRAWERS
MODULE

Content of this Order;
G 02-245 1 pc.
M 01 1 pc.
M 07 2 pc.

Consists of these modules.

D 12-245
ALFA
DOUBLE
CABINET
WITH T-SHIRT
ORGANIZER

Content of this Order;
G 02-245 1 pc.
M 02 1 pc.
M 08 1 pc.

Consists of these modules.

D 13-245
ALFA
CABINET
WITH TROUSER
RACK

Content of this Order;
G 02-245 1 pc.
M 03 1 pc.
M 06 1 pc.

Consists of these modules.

D 14-245
ALFA
DOUBLE
CABINET
WITH
SINGLE
SHELF

Content of this Order;
G 02-245 1 pc.
M 04 1 pc.
M 06 1 pc.

Consists of these modules.

D 15-245
ALFA
DOUBLE
CABINET WITH
A SHELF

Content of this Order;
G 02-245 1 pc.
M 04 1 pc.
M 07 1 pc.

Consists of these modules.

D 16-245
ALFA
DOUBLE
CABINET WITH
SEPARATOR
MODULE AND
SHELVES

Content of this Order;
G 02-245 1 pc.
M 14 1 pc.
M 06 1 pc.

Consists of these modules.

D 17-245
ALFA
DOUBLE
CABINET WITH
HIDDEN
COMPARTMENT
MODULE

Content of this Order;
G 02-245 1 pc.
M 15 1 pc.
M 04 1 pc.

Consists of these modules.

D 19-245
ALFA
DOUBLE
CABINET
WITH SHOES
ORGANIZER

Content of this Order;
G 02-245 1 pc.
M 20 1 pc.
M 04 1 pc.

Consists of these modules.

D 06-245
ALFA
SINGLE
CABINET
WITH
5 SHELVES

Content of this Order;
G 01-245 1 pc.
M 13 2 pcs.

Consists of these modules.

D 07-245
ALFA
SINGLE
CABINET
WITH
HANGER

Content of this Order;
G 01-245 1 pc.
M 10 1 pc.

Consists of these modules.

D 08-245
ALFA
SINGLE
CABINET
WITH
3 SHELVES
AND
A HANGER

Content of this Order;
G 01-245 1 pc.
M 09 1 pc.
M 13 1 pc.

Consists of these modules.

D 18-245
ALFA
SINGLE
CABINET
WITH
DRAWERS
MODULE

Content of this Order;
G 01-245 1 pc.
M 16 1 pc.
M 13 1 pc.
M 09 1 pc.

Consists of these modules.

260 CM
Our Suggestions

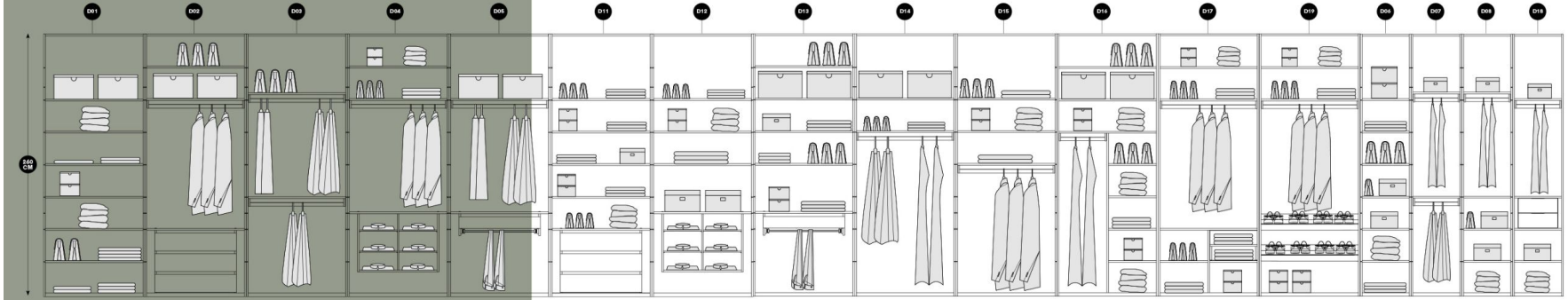

ALFA
260 CM
Wardrobe Modules



D 01-260
ALFA
DOUBLE
CABINET
WITH
5 SHELVES

Content of this Order;
G 02-260 1 pc.
M 03 2 pcs.
Consists of these modules.



D 02-260
ALFA
DOUBLE
CABINET
WITH
DRAWERS
MODULE

Content of this Order;
G 02-260 1 pc.
M 01 1 pc.
M 04 1 pc.
M 06 1 pc.
Consists of these modules.

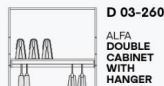

D 03-260
ALFA
DOUBLE
CABINET
WITH
HANGER

Content of this Order;
G 02-260 1 pc.
M 05 1 pc.
Consists of these modules.

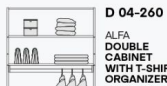

D 04-260
ALFA
DOUBLE
CABINET
WITH
T-SHIRT
ORGANIZER

Content of this Order;
G 02-260 1 pc.
M 02 1 pc.
M 04 1 pc.
M 06 1 pc.
Consists of these modules.

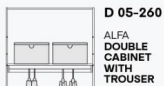

D 05-260
ALFA
DOUBLE
CABINET
WITH
TROUSER
RACK

Content of this Order;
G 02-260 1 pc.
M 03 1 pc.
M 04 1 pc.
Consists of these modules.

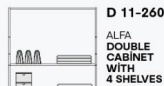

D 11-260
ALFA
DOUBLE
CABINET
WITH
4 SHELVES
AND
DRAWERS
MODULE

Content of this Order;
G 02-260 1 pc.
M 01 1 pc.
M 07 2 pc.
Consists of these modules.



D 12-260
ALFA
DOUBLE
CABINET
WITH
T-SHIRT
ORGANIZER

Content of this Order;
G 02-260 1 pc.
M 02 1 pc.
M 03 1 pc.
Consists of these modules.

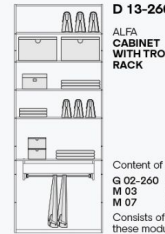

D 13-260
ALFA
CABINET
WITH
TROUSER
RACK

Content of this Order;
G 02-260 1 pc.
M 03 1 pc.
M 07 2 pc.
Consists of these modules.



D 14-260
ALFA
DOUBLE
CABINET
WITH
SINGLE
SHELF

Content of this Order;
G 02-260 1 pc.
M 04 1 pc.
M 06 1 pc.
Consists of these modules.



D 15-260
ALFA
DOUBLE
CABINET
WITH
A SHELF

Content of this Order;
G 02-260 1 pc.
M 04 1 pc.
M 07 1 pc.
Consists of these modules.

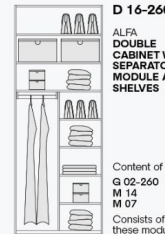

D 16-260
ALFA
DOUBLE
CABINET
WITH
SEPARATOR
MODULE AND
SHELVES

Content of this Order;
G 02-260 1 pc.
M 14 1 pc.
M 07 1 pc.
Consists of these modules.

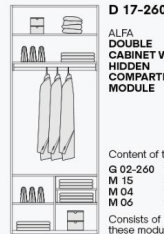

D 17-260
ALFA
DOUBLE
CABINET
WITH
HIDDEN
COMPARTMENT
MODULE

Content of this Order;
G 02-260 1 pc.
M 15 1 pc.
M 04 1 pc.
M 06 1 pc.
Consists of these modules.

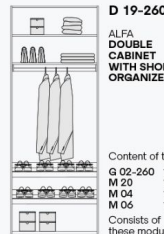

D 19-260
ALFA
DOUBLE
CABINET
WITH
SHOES
ORGANIZER

Content of this Order;
G 02-260 1 pc.
M 23 1 pc.
M 04 1 pc.
M 06 1 pc.
Consists of these modules.



D 06-260
ALFA
SINGLE
CABINET
WITH
5 SHELVES

Content of this Order;
G 01-260 1 pc.
M 13 2 pcs.
Consists of these modules.



D 07-260
ALFA
SINGLE
CABINET
WITH
HANGER

Content of this Order;
G 01-260 1 pc.
M 10 1 pc.
Consists of these modules.



D 08-260
ALFA
SINGLE
CABINET
WITH
3 SHELVES
AND
A HANGER

Content of this Order;
G 01-260 1 pc.
M 09 1 pc.
M 13 1 pc.
Consists of these modules.

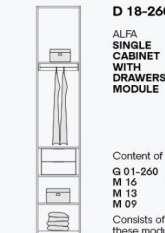

D 18-260
ALFA
SINGLE
CABINET
WITH
DRAWERS
MODULE

Content of this Order;
G 01-260 1 pc.
M 16 1 pc.
M 13 1 pc.
M 09 1 pc.
Consists of these modules.

Sliding Door 210 cm



S01-210

ALFA CABINET WITH
SLIDING DOORS

G 03-210 1 pc.
M 03 1 pc.
M 15 1 pc.
M 08 1 pc.
M 17 1 pc.

S02-210

ALFA CABINET WITH
SLIDING DOORS

G 03-210 1 pc.
M 01 1 pc.
M 17 1 pc.
M 02 1 pc.
M 07 1 pc.

S03-210

ALFA CABINET WITH
SLIDING DOORS

G 03-210 1 pc.
M 07 1 pc.
M 08 1 pc.
M 17 1 pc.
M 20 1 pc.

S04-210

ALFA CABINET WITH
SLIDING DOORS

G 03-210 1 pc.
M 14 1 pc.
M 01 1 pc.
M 17 1 pc.

Sliding Door 228 cm

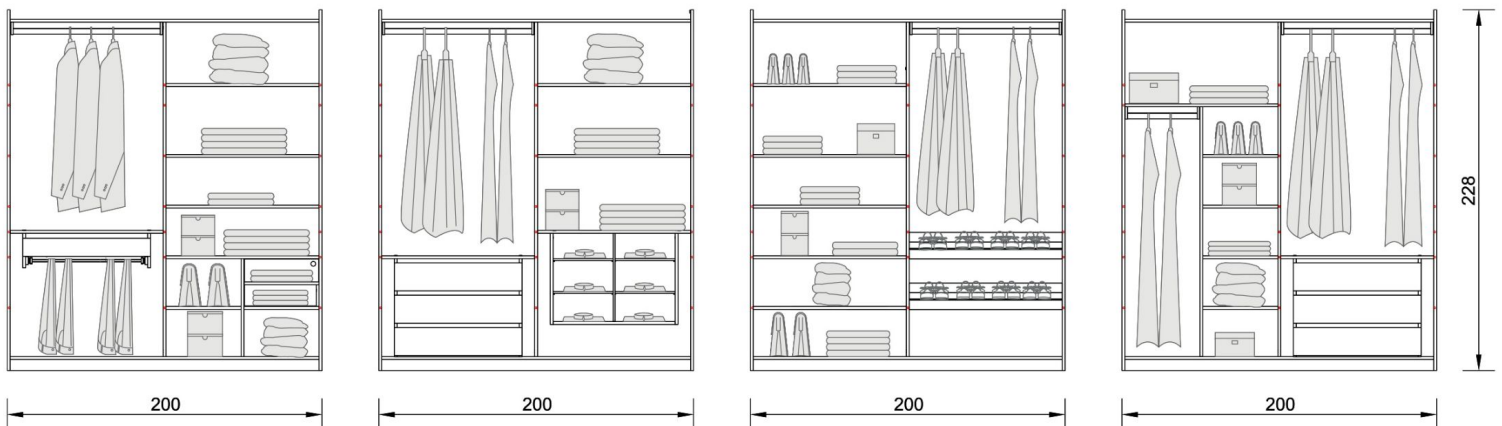

S01-228

ALFA CABINET WITH
SLIDING DOORS

G 03-228 1 pc.
M 03 1 pc.
M 15 1 pc.
M 08 1 pc.
M 17 1 pc.

S02-228

ALFA CABINET WITH
SLIDING DOORS

G 03-228 1 pc.
M 01 1 pc.
M 17 1 pc.
M 02 1 pc.
M 07 1 pc.

S03-228

ALFA CABINET WITH
SLIDING DOORS

G 03-228 1 pc.
M 07 1 pc.
M 08 1 pc.
M 17 1 pc.
M 20 1 pc.

S04-228

ALFA CABINET WITH
SLIDING DOORS

G 03-228 1 pc.
M 14 1 pc.
M 01 1 pc.
M 17 1 pc.

Sliding Door 245 cm

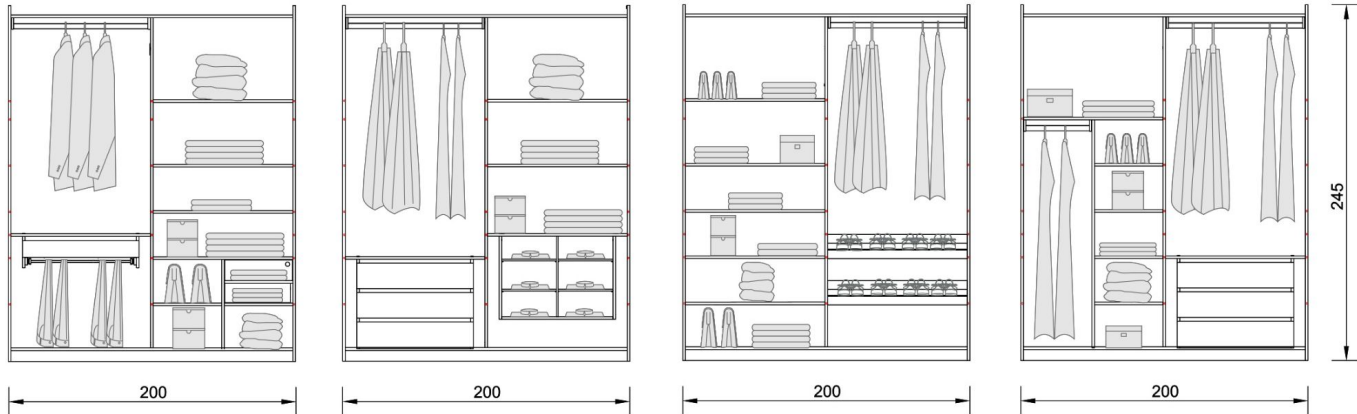

S01-245 ALFA CABINET WITH SLIDING DOORS

G 03-245 1 pc.
M 03 1 pc.
M 15 1 pc.
M 08 1 pc.
M 17 1 pc.

S02-245 ALFA CABINET WITH SLIDING DOORS

G 03-245 1 pc.
M 01 1 pc.
M 17 1 pc.
M 02 1 pc.
M 07 1 pc.

S03-245 ALFA CABINET WITH SLIDING DOORS

G 03-245 1 pc.
M 07 1 pc.
M 08 1 pc.
M 17 1 pc.
M 20 1 pc.

S04-245 ALFA CABINET WITH SLIDING DOORS

G 03-245 1 pc.
M 14 1 pc.
M 01 1 pc.
M 17 1 pc.

Sliding Door 260 cm

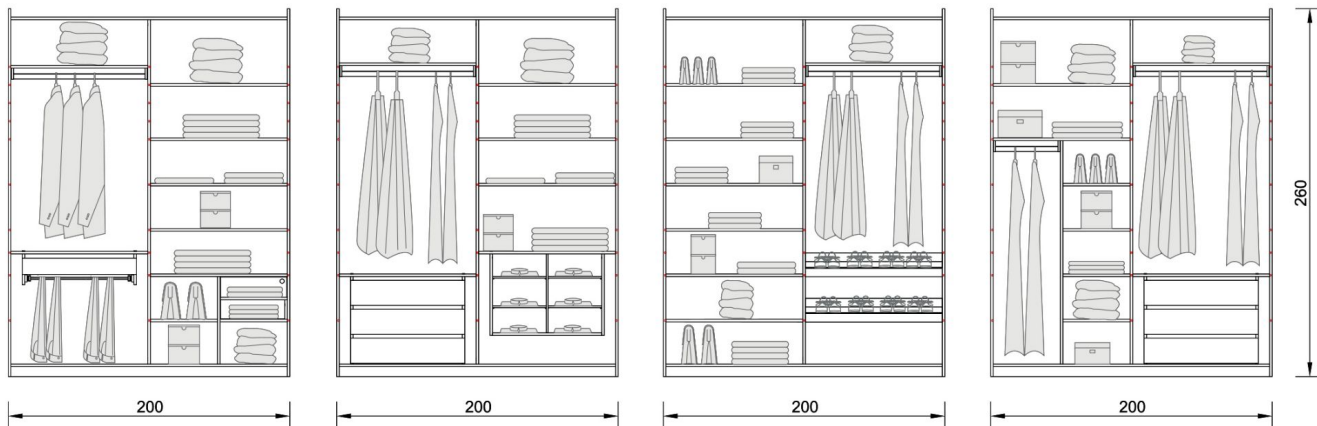

S01-260 ALFA CABINET WITH SLIDING DOORS

G 03-260 1 pc.
M 03 1 pc.
M 15 1 pc.
M 08 1 pc.
M 17 1 pc.

S02-260 ALFA CABINET WITH SLIDING DOORS

G 03-260 1 pc.
M 01 1 pc.
M 17 1 pc.
M 02 1 pc.
M 07 1 pc.

S03-260 ALFA CABINET WITH SLIDING DOORS

G 03-260 1 pc.
M 07 1 pc.
M 08 1 pc.
M 17 1 pc.
M 20 1 pc.

S04-260 ALFA CABINET WITH SLIDING DOORS

G 03-260 1 pc.
M 14 1 pc.
M 01 1 pc.
M 17 1 pc.

DESIGN YOUR OWN WARDROBE

ALFA OFFERS ALL USERS THE FREEDOM TO DESIGN THEIR OWN WARDROBE OR DRESSING ROOM

By placing the inside modules as you wish into the holes drilled on the right and left sides, you can create the most suitable cabinet for yourself. With this feature in single and double body cabinets, ALFA allows you to determine an unlimited number of cabinet options.

On the following pages, you can review our recommendations for the cabinet that is closest to ideal, and make your decision comfortably.



The inside structure of D 09 and D 10 are standart, they can only change by size.

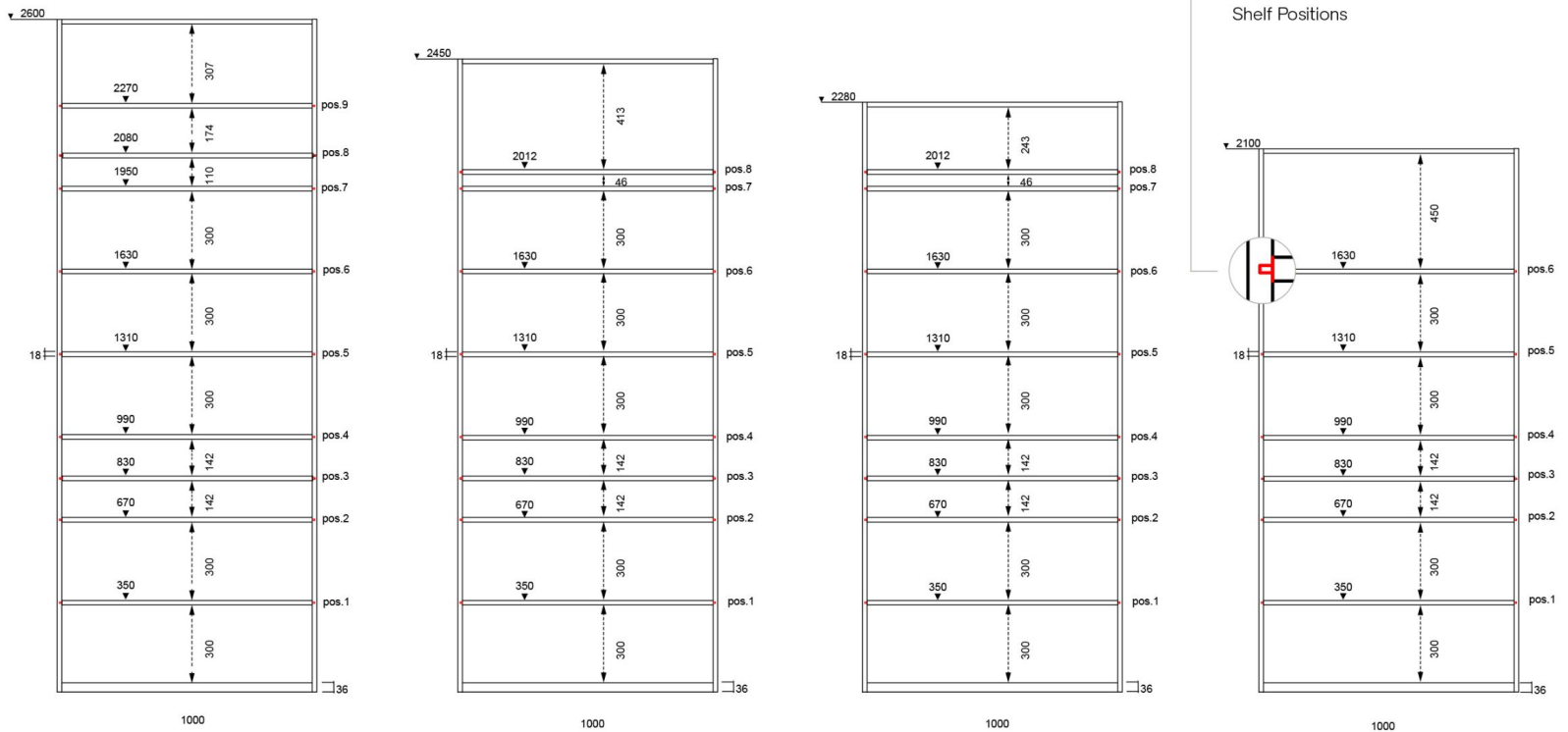

EXAMPLE :

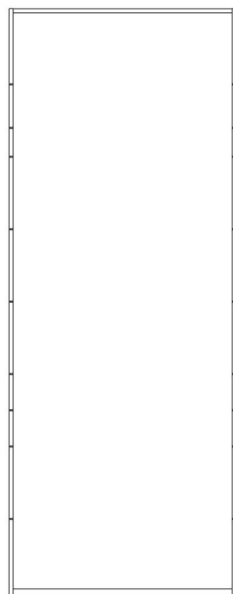

G 02
ALFA
DOUBLE MAIN
CABINET

STEP 1

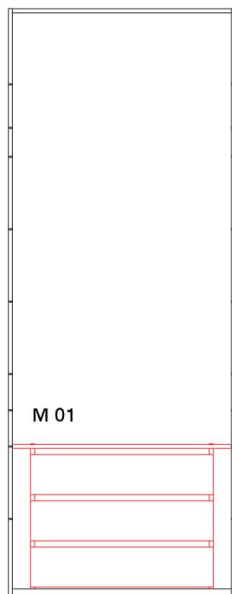

M 01
ALFA
DRAWERS
MODULE

STEP 2

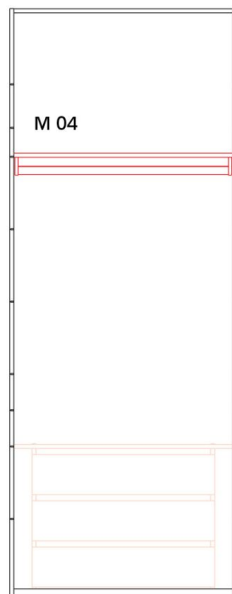

M 04
ALFA
LONG SHELF MODULE
WITH HANGER

STEP 3

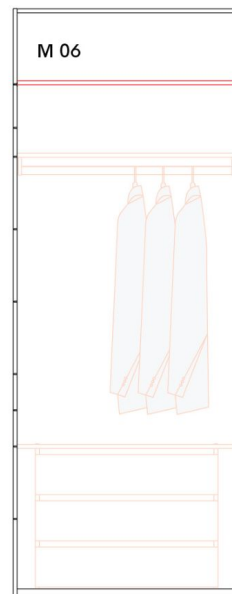

M 06
ALFA
LONG SHELF
MODULE

STEP 4

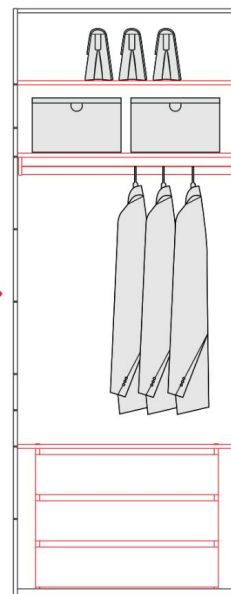

D 02
ALFA
DOUBLE CABINET WITH
DRAWERS MODULE

G 02-260 1 pc.
M 01 1 pc.
M 04 1 pc.
M 06 1 pc.



G 01
ALFA
SINGLE MAIN
CABINET

STEP 1

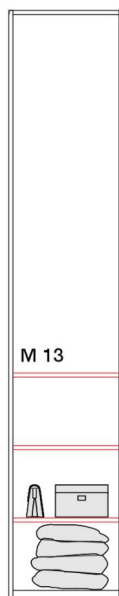

M 13
ALFA
SHORT SHELF
MODULE 3 PCS.

STEP 2

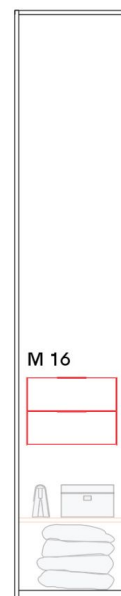

M 16
ALFA
SHORT DRAWERS
MODULE

STEP 3

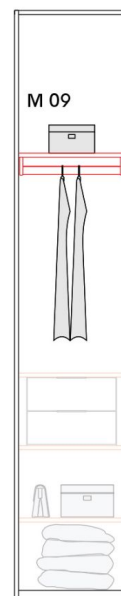

M 09
ALFA
SHORT SHELF
MODULE WITH
HANGER

STEP 4

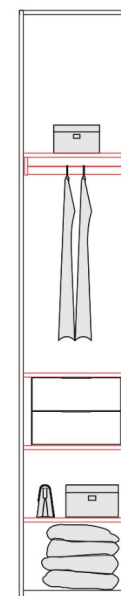

D 18
ALFA
SINGLE CABINET WITH
DRAWERS MODULE

G 01-260 1 pc.
M 16 1 pc.
M 13 1 pc.
M 09 1 pc.

MAKEUP MODULES

ALFA offers specially designed makeup modules to make women's makeup routines more enjoyable by considering all the areas they need.

The makeup modules, available in 5 different color options, help women organize their beauty routines and meet their storage needs. Makeup modules include elements such as drawers, shelves, and mirrors, allowing for customizable additions and removals.

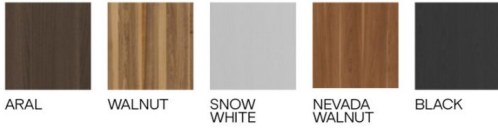

 Top Module can be done either with Wooden or aluminum Framed Tempered glass doors.

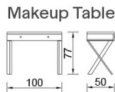
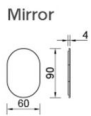
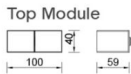

Makeup Unit

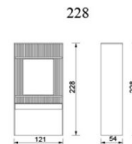
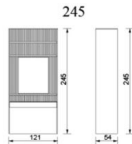
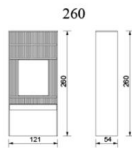

MAKEUP TABLE



MAKEUP UNIT



ALFA
POUF



ALFA
CHAIR

ISLANDS

Offered in 5 different color options to complement your wardrobe style. Each island comes with drawers and compartments to help you easily organize your accessories. The durable structure, high-quality materials, and stylish design of our islands make them ideal for adding elegance and functionality to any dressing room.

Our islands' durable construction, high-quality materials, and sleek design make them ideal for adding elegance and functionality to any dressing room.



Island (Big)

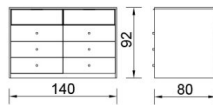

- 16 drawers
- Self-closing tandem rails
- Top panel and drawer fronts with aluminum frames and tempered glass
- Special compartments for your jewelry and accessories
- Velvet-lined drawer bottoms



ARAL



WALNUT



SNOW WHITE



NEVADA WALNUT



BLACK



Island (Small)

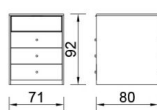

- 8 drawers
- Self-closing tandem rails
- Top panel and drawer fronts with aluminum frames and tempered glass
- Special compartments for your jewelry and accessories
- Velvet-lined drawer bottoms

CABINET SIDE PANEL EXTENSION

If you want your wardrobe to have a more sturdy and sophisticated appearance, this extension is just for you!



Side Panel Extensions do not apply to Cabinets with a height of 210 cm.



Side Panel Extensions do not apply to Cabinets with Sliding doors.





• For Hinged Cabinets

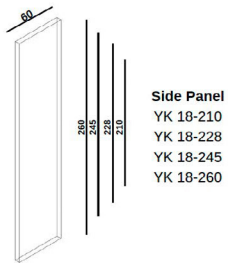

Side Panel
 YK 18-210
 YK 18-228
 YK 18-245
 YK 18-260

◦ For Hinged Cabinets Left and right Side panels are identical



• For Sliding Door Cabinet's Left Side

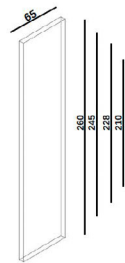

Sliding Door Side Panel
 SYK 18-210 (Left)
 SYK 18-228 (Left)
 SYK 18-245 (Left)
 SYK 18-260 (Left)

• Side Panels For Sliding Door Cabinets Are shown Above



• For Sliding Door Cabinet's Right Side

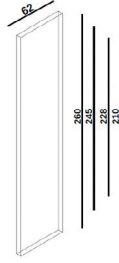

Sliding Door Side Panel
 SYK 18-210 (Right)
 SYK 18-228 (Right)
 SYK 18-245 (Right)
 SYK 18-260 (Right)

Sliding Door Side Panel
210 cm (Left)

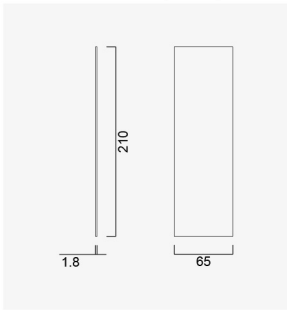

Sliding Door Side Panel
210 cm (Right)

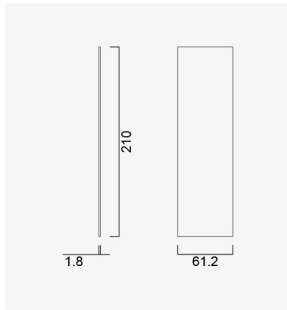

Sliding Door Side Panel
228 cm (Left)

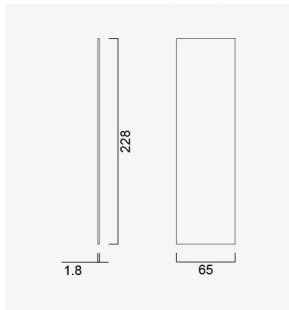

Sliding Door Side Panel
228 cm (Right)

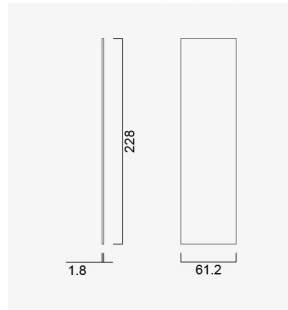

Sliding Door Side Panel
245 cm (Left)

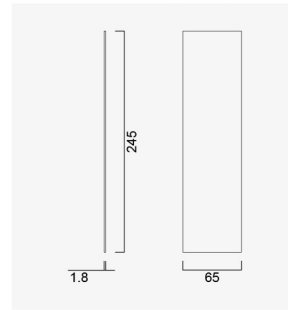

Sliding Door Side Panel
245 cm (Right)

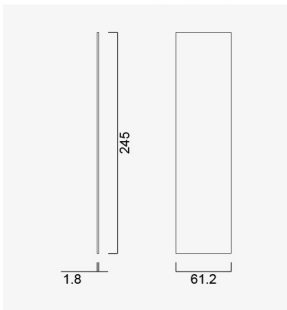

Sliding Door Side Panel
260 cm (Left)

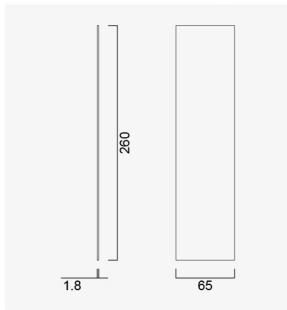

Sliding Door Side Panel
260 cm (Right)

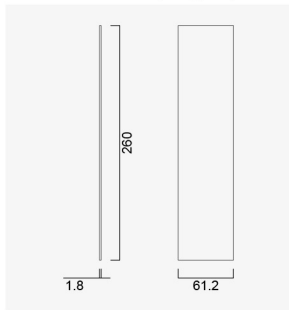

Double-Single Cabinet
Side Panel 210 cm

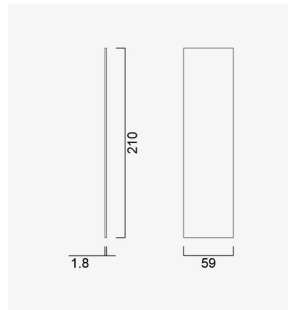

Double-Single Cabinet
Side Panel 228 cm

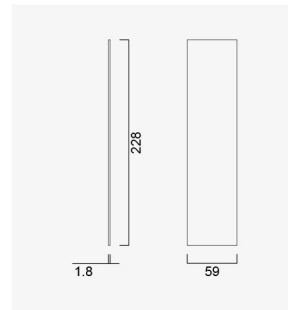

Double-Single Cabinet
Side Panel 245 cm

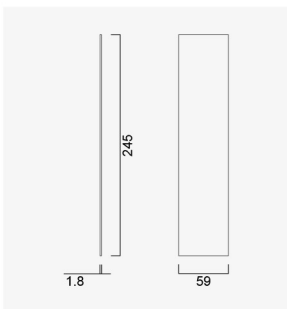

Double-Single Cabinet
Side Panel 260 cm

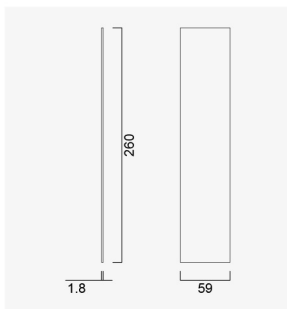

TV Module
230 cm

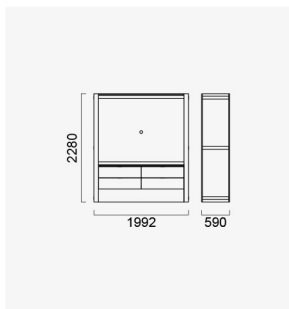

TV Module
245 cm

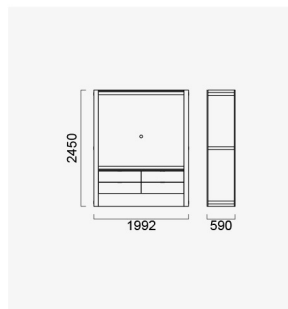

TV Module
260 cm

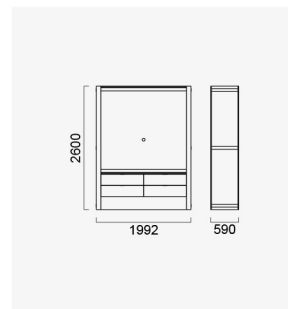

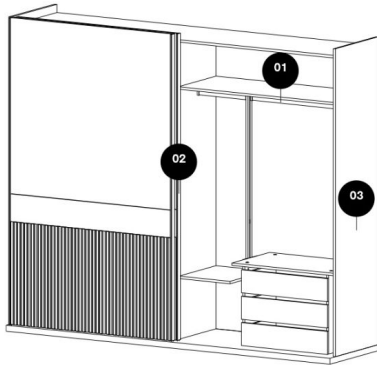

» 01 HANGER

Using elastomer in our hangers prevents them from scratching and making noises.

» 02 PROFILE

2mm Aluminum profiles with inox coating resists color change, bending and scratching.

» 03 CABINET

As our Cabinets are delivered in disassembled conditions it is very important to implant Rafix and Minifix Assembly solutions to make the process simplified and at the same time make sure that finished product is solid to last for a long period of time.

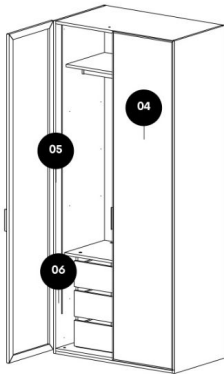

» 04 TEMPERED GLASS

5 times more durable than an ordinary glass. When broken falls into small pieces to prevent serious injuries.

» 05 LED

Homogeneous distribution of light throughout our wardrobes are managed by the control cards. UL Certified.

» 06 HINGES

Soft closing hinges from HAFELE installed on the cabinet doors with dowels. 5 pieces of hinge holding each door to handle the weight and provide smooth operation.

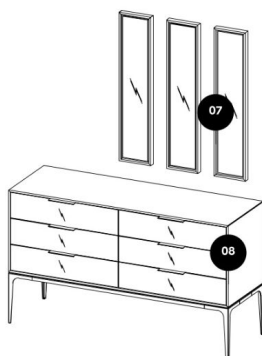

» 07 PAINTING

Polyurethane-based paints with high physical and chemical resistance provides great UV resistance.

» 08 RAILS

German manufactured, Self-retracting, full extension telescopic Hettich Rails with ISO certification.